

Exploded view of Dust Extractor 1230 L & 1242 L • AFC

Updated 01.04.2019

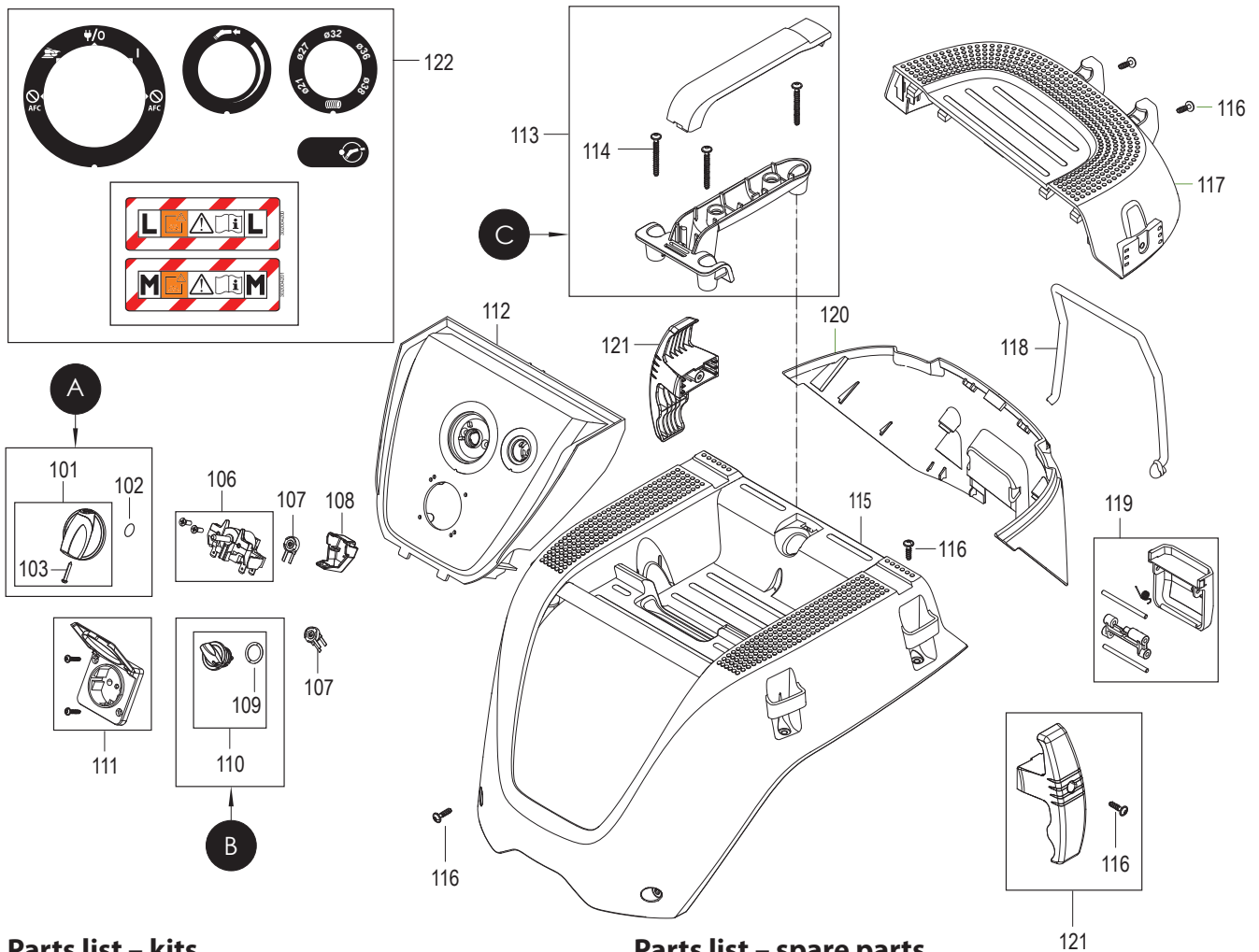

Parts list – kits

Mirka code	Item	Description	Kit	Qty
8999603611		Rotary knob kit	A	
	101	Rotary knob		1
	102	O-ring 10 x 2,5 mm		1
	103	Screw 2,9 x 19 mm		1
8999211011		Turning knob kit	B	
	109	O-ring 16 x 2 mm		1
	110	Turning knob		1
8999211311		Handle kit	C	
	113	Handle kit		1
	114	Screw 5 x 45 mm		3

Parts list – spare parts

Mirka code	Item	Description	Kit	Qty
	101	Rotary knob kit	A	1
	102	O-ring 10 x 2,5 mm	A	1
	103	Screw 2,9 x 19 mm	A	1
8999210611	106	Rotary switch 16 A		2
8999210711	107	Potentiometer with wire		2
8999210811	108	Cap for pot-meter		1
	109	O-ring 16 x 2 mm	B	1
	110	Turning knob kit	B	1
8999601911	111	Socket 16 A / 250 V, EU		1
8999211111	111	Socket 10 A / 250 V, AU/NZ		1
8999212311	111	Socket 10 A / 250 V, CH		1
8999212811	111	Socket 10 A / 250 V, CN		1
8999211211	112	Control panel L AFC		1
	113	Handle	C	1
	114	Screw 5 x 45 mm	C	3
8999211511	115	Top cover		1
8999701411	116	Screws 5 x 18 mm		17
8999211711	117	Hatch door upper cover for AFC		1
8999211811	118	Cord strap		1
8999211911	119	Hatch door clamp kit		1
8999212011	120	Hatchback lower cover		1
8999212111	121	Hose hook		1
8999212211	122	Label kit AFC control panel & dust class		1

Exploded view of Dust Extractor 1230 L & 1242 L • AFC

Updated 18.03.2019

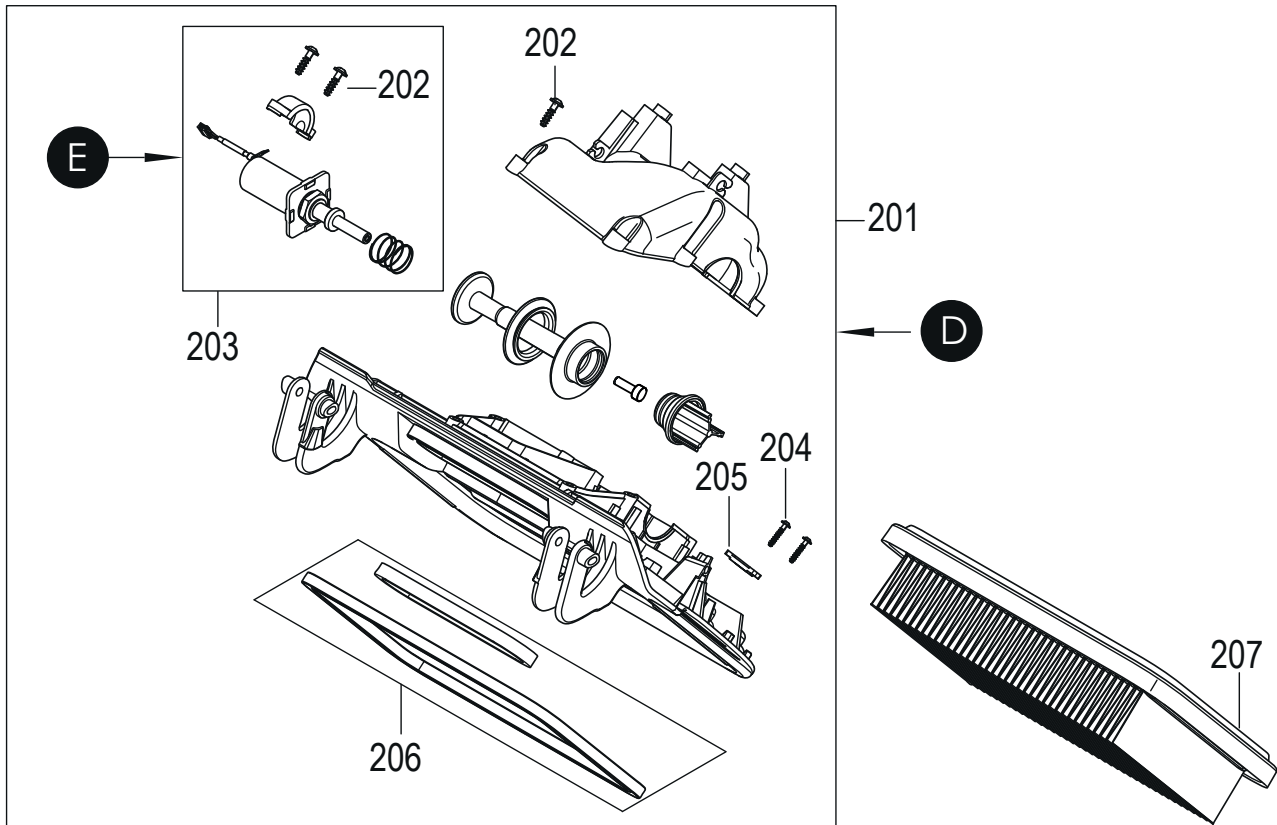

Parts list – kits

Mirka code	Item	Description	Kit	Qty
8999220811		Hatch door frame kit AFC	D	
	201	Hatch door frame		1
	202	Screws 5 x 18 mm		15
	203	Solenoid 220–240 V		1
	204	Screws 3,5 x 18 mm		1
	205	Strap 3 x 8 x 33 mm		1
	206	Hatch door filter gasket		1
8999220311		Solenoid kit 220–240 V AFC	E	
	202	Screws 5 x 18 mm		2
	203	Solenoid 220–240 V		1

Parts list – spare parts

Mirka code	Item	Description	Kit	Qty
	201	Hatch door frame AFC	D	1
	202	Screws 5 x 18 mm	D, E	15, 2
	203	Solenoid 220–240 V AFC	D, E	1
	204	Screws 3,5 x 18 mm	D	2
	205	Strap 3 x 8 x 33 mm	D	1
	206	Hatch door filter gasket	D	1
8999100411	207	Filter		1

Exploded view of Dust Extractor 1230 L & 1242 L • AFC

Updated 28.01.2019

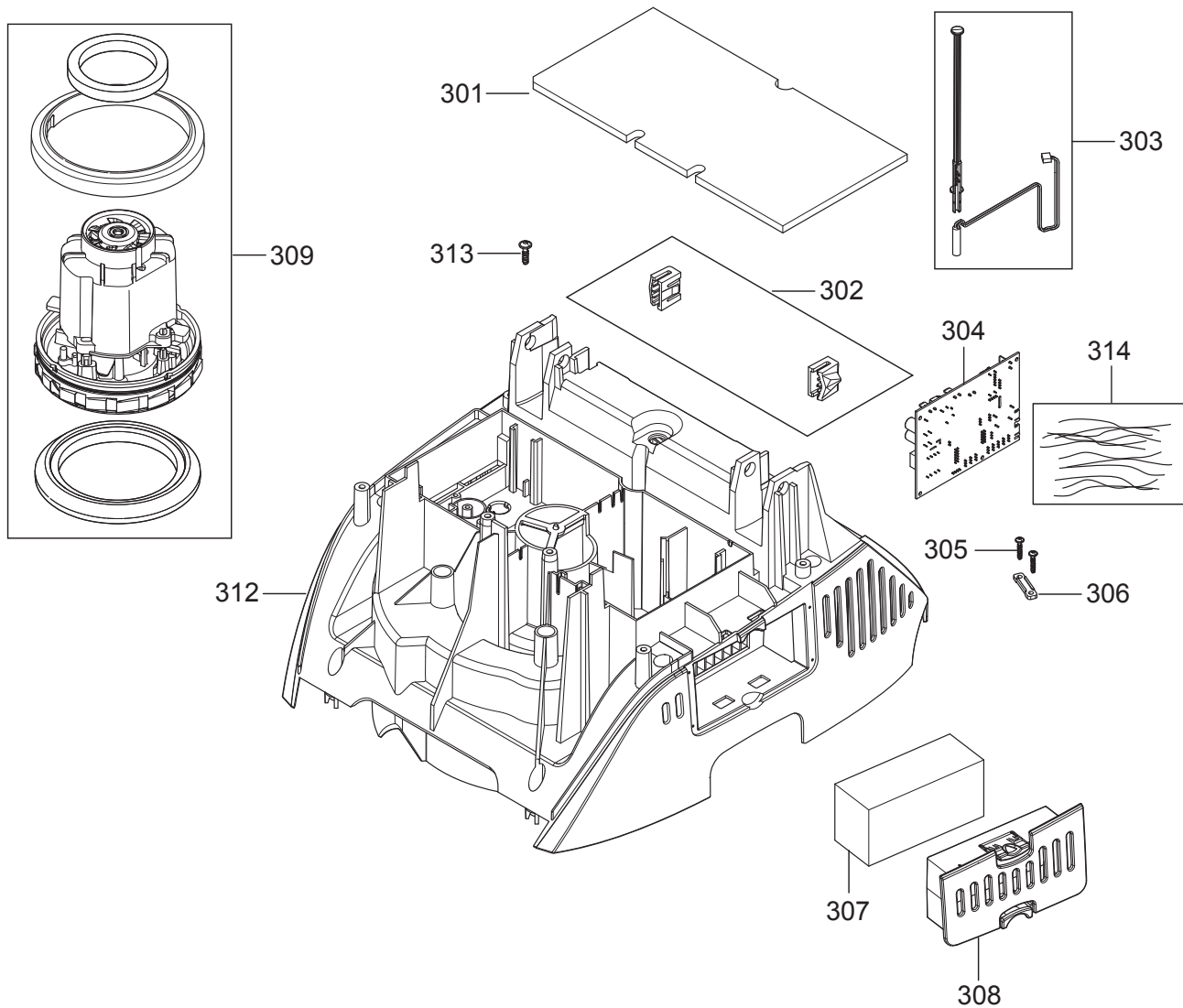

Parts list – spare parts

Mirka code	Item	Description	Kit	Qty
8999230111	301	Foam sealing 298 x 148 mm		1
8999230211	302	Hatch door hinge snap		2
8999230311	303	Reed sensor with applicator		1
8999230411	304	Electronic Board 230–240 V L AFC		1
8999701311	305	Screw 3,5 x 18 mm		2
8999701811	306	Strap cable		1
8999110111	307	Motor cooling filter		1
8999230811	308	Cover for motor cooling filter		1
8999230911	309	Motor assembly 230 V		1
8999231211	312	Airguide L		1
8999701411	313	Screw 5 x 18 mm		9
8999231411	314	Wire / Capacitor kit		6

Exploded view of Dust Extractor 1230 L & 1242 L • AFC

Updated 01.04.2019

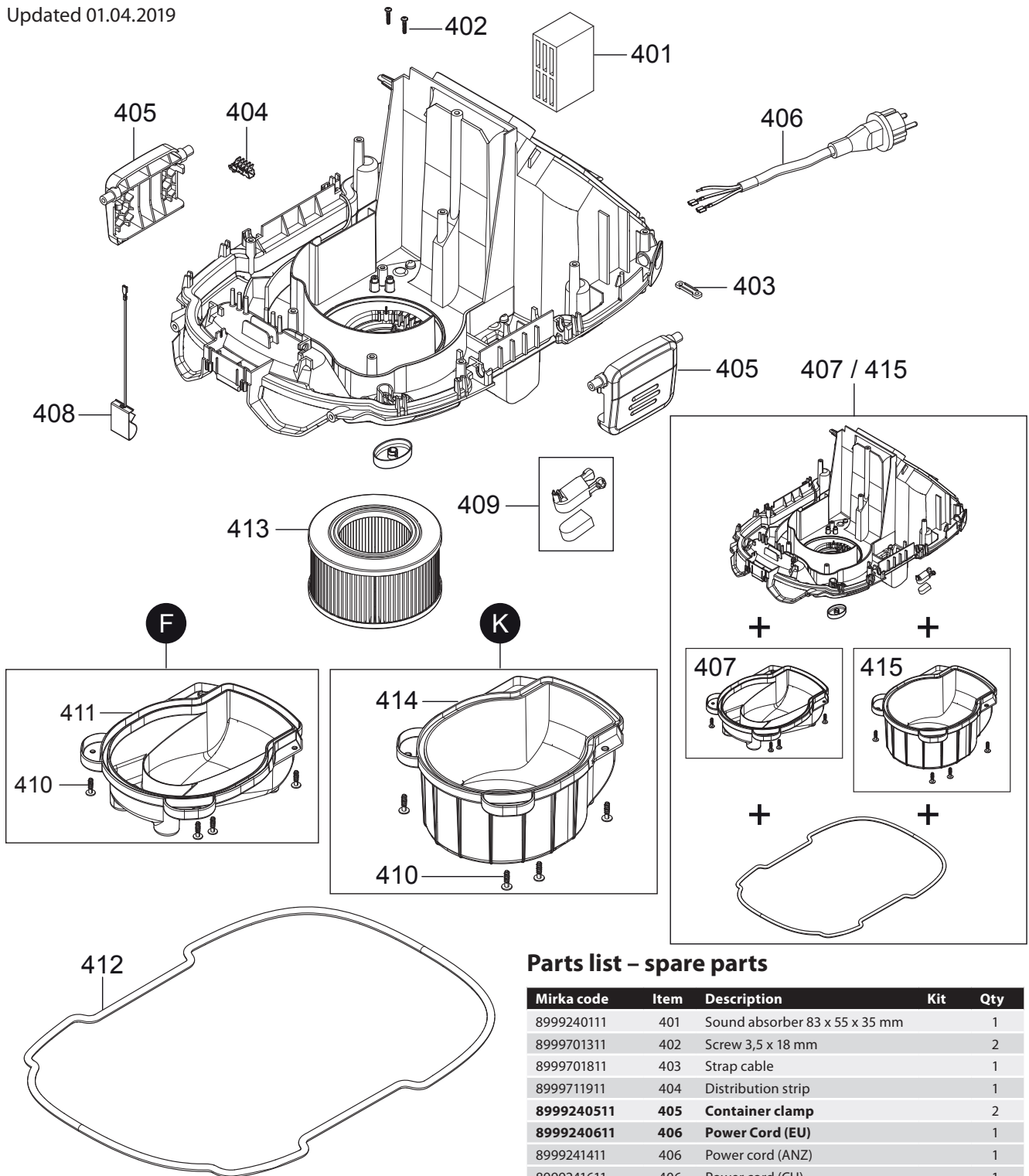

Parts list – kits

Mirka code	Item	Description	Kit	Qty
8999241111		Air flow cover kit	F	
	410	Screws 5 x 18 mm, stainless steel		4
	411	Air flow cover kit, black		1
8999100811		Hepa filter cover kit	K	OPT.
	410	Screws 5 x 18 mm, stainless steel		4
	414	Hepa filter cover		1

Parts list – spare parts

Mirka code	Item	Description	Kit	Qty
8999240111	401	Sound absorber 83 x 55 x 35 mm		1
8999701311	402	Screw 3,5 x 18 mm		2
8999701811	403	Strap cable		1
8999711911	404	Distribution strip		1
8999240511	405	Container clamp		2
8999240611	406	Power Cord (EU)		1
8999241411	406	Power cord (ANZ)		1
8999241611	406	Power cord (CH)		1
8999241711	406	Power cord (CN)		1
8999240711	407	Base plate with air flow cover		1
8999240811	408	Contact spring with wire		1
8999240911	409	Floater with magnet		1
8999241011	410	Screws 5 x 18 mm, stainless steel	F, K	4
	411	Air flow cover, black	F	1
8999241211	412	Container sealing		1
8999100711	413	Hepa filter		OPT.
	414	Hepa filter cover	K	OPT.
8999141511	415	Base plate with hepa filter cover		OPT.

Exploded view of Dust Extractor 1230 L & 1242 L • AFC

Updated 15.04.2019

1230 L

Container 30 liter

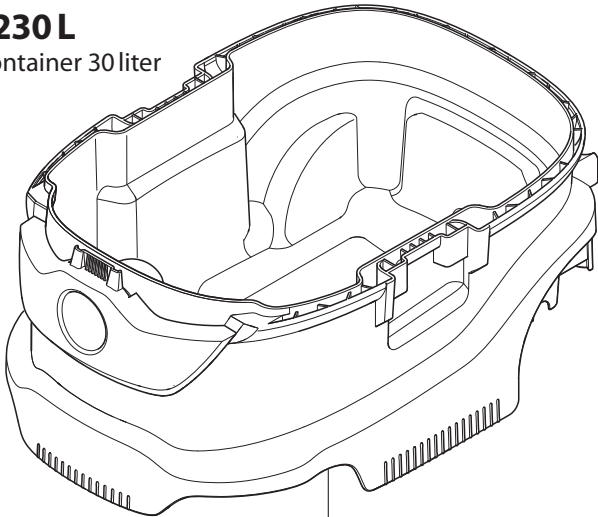

1242 L

Container 42 liter

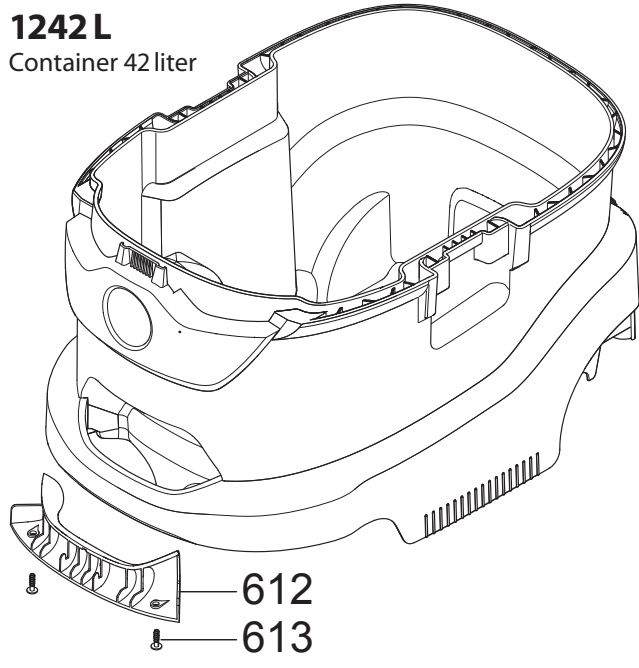

501
503

602

612
613

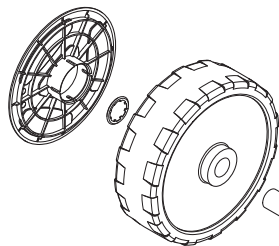

505

504

506

Only with item 602

603

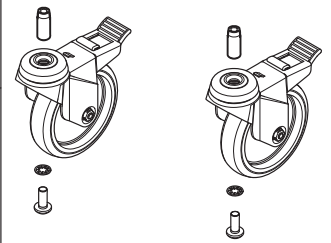

507

507

508

Parts list – spare parts

Mirka code	Item	Description	Kit	Qty
8999250111	501	Container 30 L		1
8999250311	503	Front wheels D75 mm, 2/pack		2
8999250411	504	Screw 5 x 35 mm		1
8999703611	505	Wheel axle		1
8999150611	506	Rear wheel D175		2
8999703911	507	Clamping ring		2
8999250811	508	Wheel cap		2
8999260211	602	Container 42 L		1
8999260311	603	Castor wheel D100 with brake		2
8999261211	612	Handle inner for container 42 L		1
8999701411	613	Screw 5 x 18 mm		2